





















PO Box 128 | 504 Highway 63 South | Freeburg, MO 65035 | 800-347-0438 | 573-469-4151 (fax)

Installation Guidelines for M-Series aluminum 4-panel sliding door. New construction nail fin installation with a drainable weather resistant barrier.

Read these instructions completely before starting any installation. Failure to install and maintain our product according to these instructions may void any product warranty. Please visit our website at www.quakerwindows.com or call 1-800-347-0438 for additional information.

| Tools required by installer: | | Materials required by installer: | |
|-------------------------------------|---|--|---|
| Safety glasses |  | Utility knife |  |
| Drill/Driver |  | Caulk gun |  |
| Level |  | Tape measure |  |
| Hammer |  | J-roller |  |
| Putty Knife |  | Staple Gun |  |
| | | Foam Backer Rod |  |
| | | Shims (Waterproof) |  |
| | | Flashing tape (Self-Adhering) |  |
| | | Fasteners |  |
| | | Minimally Expanding Foam |  |
| | | Sealant |  |
| | | Water Resistive Barrier/House Wrap (WRB) |  |
| | | Denatured Rubbing Alcohol |  |
| | | Drip Cap |  |

⚠ WARNING

Tools

- Follow manufacturers instructions for safe operation of tools, and ladders/scaffolding. Always wear safety glasses. Failure to do so could result in injury, product or property damage.

Handling

- Do not store units outside, or in a hot environment. Doing so could result in product damage.
- **Do not carry flat.** Doing so could result in product damage, injury, or property damage.
- Stack units as straight as possible to avoid bowing. **Do not lay flat!**

Glass

- If broken, glass can fragment causing injury. All Quaker products are available with safety glass. In many areas, local building codes require safety glass in certain locations and/or applications. Unless safety glass is ordered, Quaker windows are not provided with safety glass. Before ordering, consult your local building codes for more definitive information.

Fastening

- Metal fasteners and components could corrode when used with preservative-treated lumber. Use approved fasteners and components to fasten window or door. Failure to do so could cause a failure resulting in injury, product or property damage.
- Fastener must attach to a structural framing member with 1 1/2" minimum fastener embedment, or minimum 3 full threads with a minimum 5/16" head as products were tested with.
- **Quaker does not supply anchorage/fastener calculations, and is not responsible for determining structural adequacy of the anchorage and fasteners used to install our products, or the openings into which they are installed.**
- **Do not over drive screws or nails.** Doing so could result in product damage.

CAUTION**Installation**

- Always support window or door in opening until fully fastened. Failure to do so could result in the window or door falling out or causing injury, product, or property damage.
- Nailing flanges and drip caps (integral or applied) **do not** take the place of window flashing. All windows and doors must be properly flashed and sealed with material compatible sealant for protection against water and air infiltration around the entire perimeter. Failure to do so could result in product or property damage.
- **Do not** set window directly on sill plate. Place shims under the side jambs. Window or door must be properly shimmed. Failure to do so could affect operation and product performance and could result in product damage.
- Live or dead loads transferred into our product can affect functionality, damage frame joinery or cause glass failures. Dead loads such as upper levels, roof, etc. Should be constructed before window or door is installed.
- Loads shall be designed to withstand the most critical effects of load factors and load combinations as required by the building code. (Loads are including but not limited to Live, Dead, Collateral, Auxiliary, Thermally induced, Seismic, etc.)
- Maximum vertical deflection of the header under all Load combination should not exceed the Span/720 or 1/4" whichever is less.
- Windows and doors have small parts. Small parts if swallowed could pose a choking hazard to young children. Dispose of unused, loose, or easily removed small parts. Failure to do so could result in injury.
- **Do not** drill through or into window sill to install alarm wires.

Sealing

- Follow instructions of foam, sealant, and flashing manufacturers regarding safety, material application, compatibility, and periodic maintenance for continued weather resistance of their products. Failure to do so could result in product or property damage. **DO NOT** overfill between the frame and opening.
- Minimally expanding foam insulation must be compliant with AAMA 812-04.
- Quaker recommends 100% silicone (ASTM C920 compliant) neutral cure only sealant. Always clean all areas where sealant will be applied. Failure to do so could result in product or property damage.
- Flashing tape must meet ASTM-D779 performance requirements.
- Maintain a minimum of 1/4" between the window or door frame and exterior finish materials. Failure to do so could result in product or property damage.

Joining

- Do not join any window or door to any window or door not designed for joining. Joined windows and doors must be individually supported in the opening. Failure to do so could affect operation and product performance and could result in product or property damage.

Cleaning

- Acid solutions used for cleaning will damage glass, fasteners, hardware, and metal flashing. Protect these products and follow cleaning products manufacturers instructions. If acid contacts the window or door, wash all surfaces immediately with clean water.
- **Do not** use razor blades to clean glass surface. Glass damage could result.
- Clean glass using liquid glass cleaner.
- Clean frame, sash, panels, and insect screens using mild detergent and warm water with a soft cloth or brush.

IMPORTANT

- Buildings constructed prior to 1978 could contain lead paint which could be disturbed during window or door replacement. For more information on proper management of lead paint, go to: www.epa.gov/lead
- Care must be taken to properly recycle or dispose of old materials. Any recyclable materials should be separated from non-recyclable or hazardous materials. Please consult with local or state authorities regarding proper disposal of non-recyclable or hazardous materials.
- These are generic instructions intended to cover most common situations, which may not be appropriate for all installations due to building design, construction materials, or methods used and/or building or site conditions. Consult a contractor or architect for recommendations.
- Inspect all units for any damage or defects prior to installation. Contact the nearest Quaker distributor if there are any problems.

1

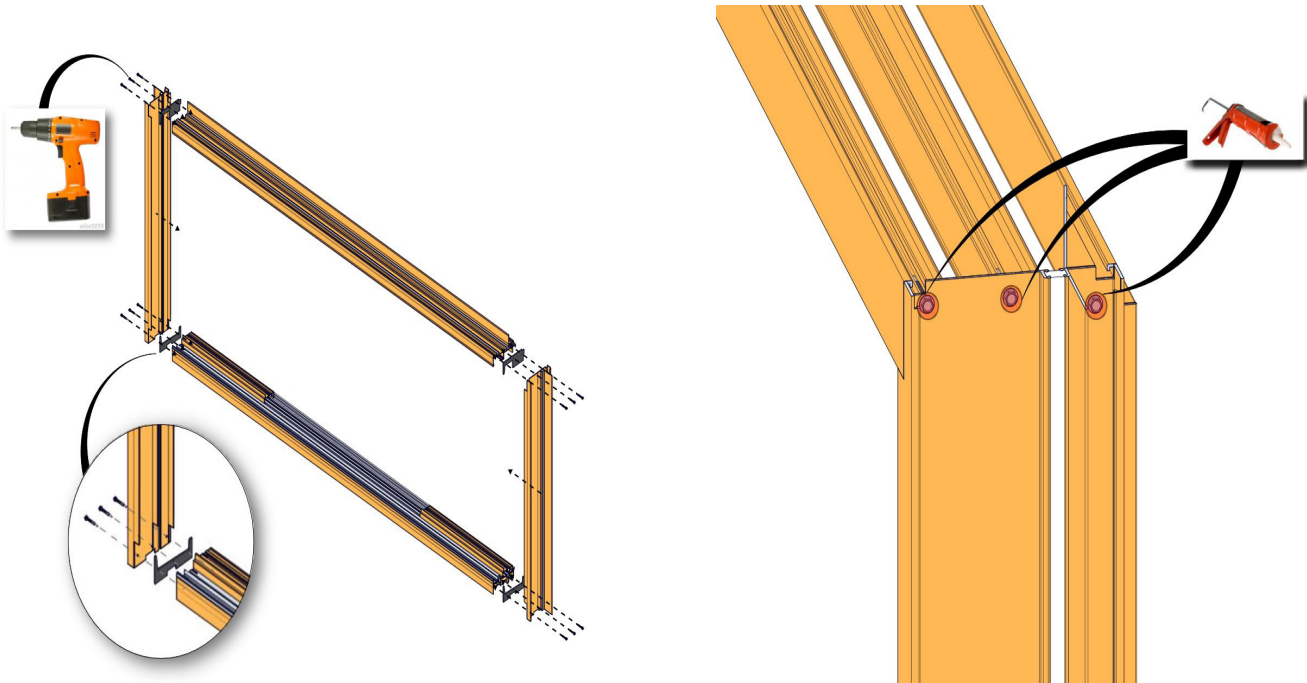

Assemble jambs to head and sill assembly with the 12 fasteners provided (MH8-18X11/2 LP). Make sure to use the two head and sill gaskets provided, and seal around screw heads and outside corners.

2

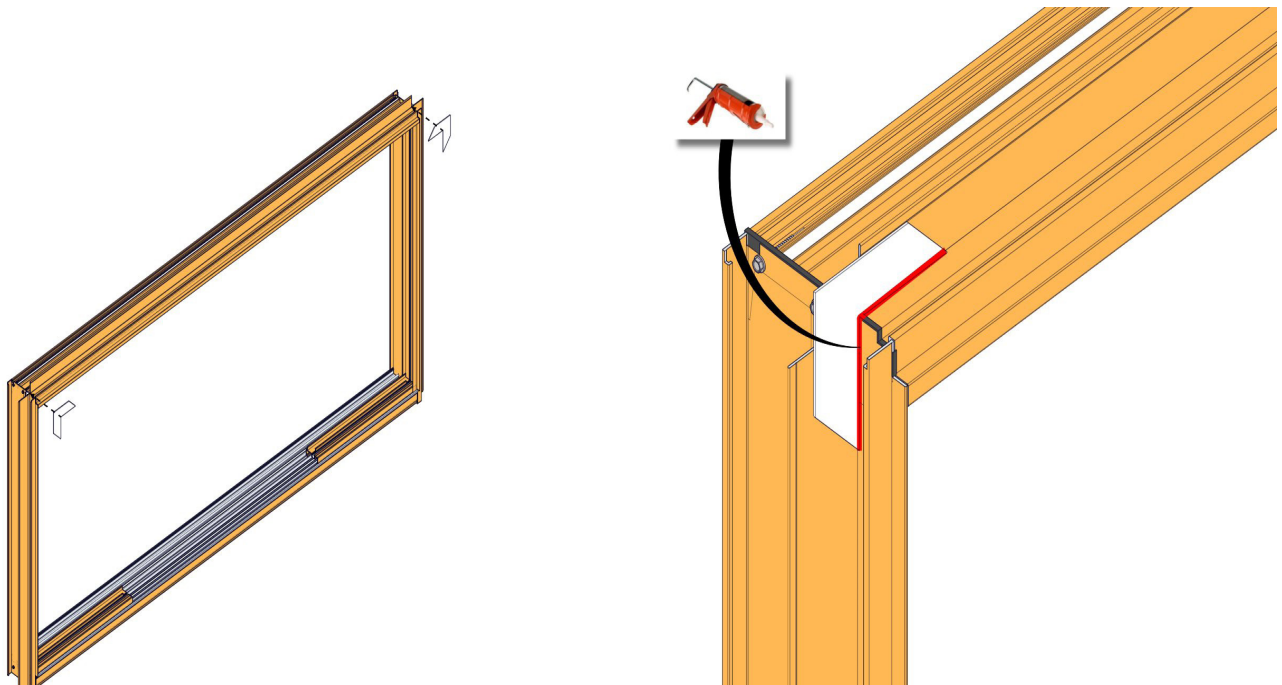

Clean the nail fin corners prior to installing the corner gaskets to the exterior side of nail fin corner gaps. Apply sealant along the edge where the gasket meets the door frame.

3

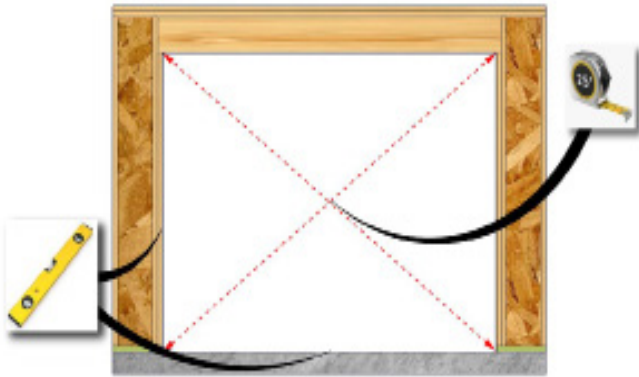

Measure and verify the opening is sized correctly. The rough opening should be a minimum 1/2" (but not to exceed 1") wider and taller than the unit. Allow additional space for flashing thickness, installation clips, joining components, and their fasteners.

4



Check that the opening is square. The diagonal measurements need to be within 1/8" of each other. Verify the rough opening is plumb and level. The sill plate beneath the unit must be level for proper unit operation.

5

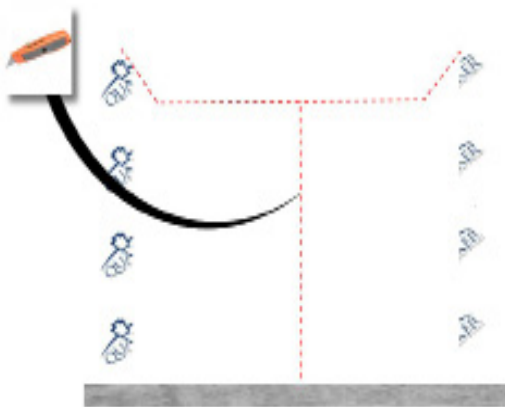

Apply the house wrap according to the manufacturer's instructions and cut T-pattern opening as shown above. Cut top flap angles at 45 degrees and 1" longer than the width of flashing tape being used.

6

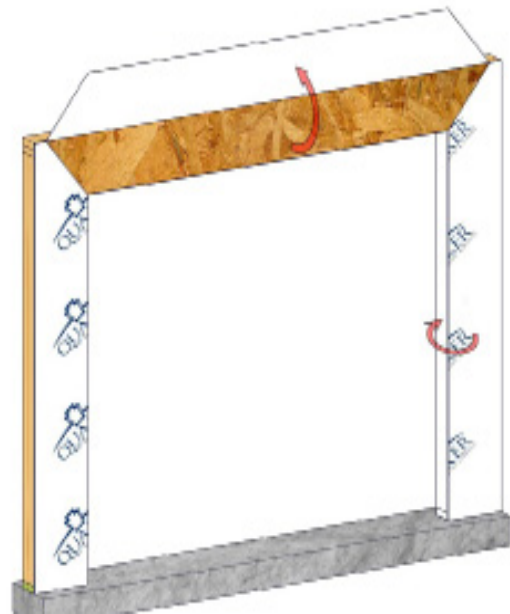

Fold the house wrap to the interior and staple it to the interior framing. Fold the house wrap flap up and temporarily tape it in place.

7

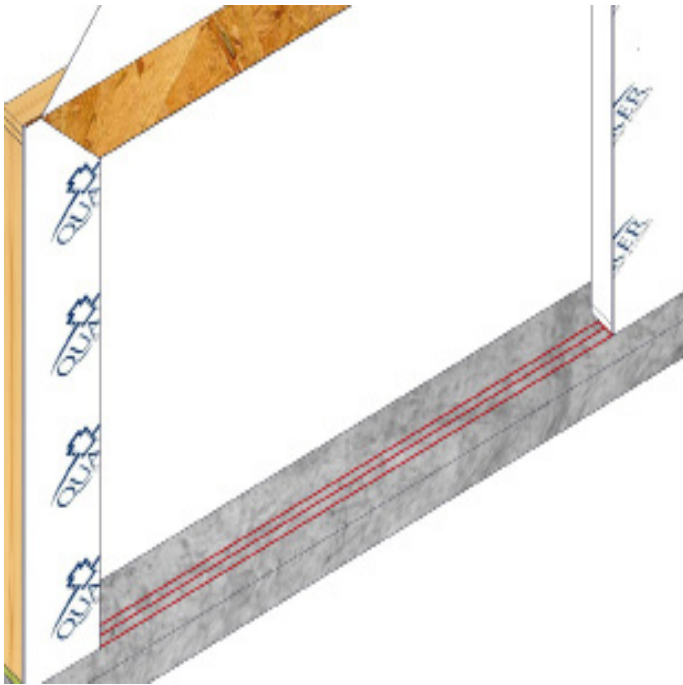

Apply three 3/8" continuous beads of silicone across the entire width of the rough opening sill, and a 3/8" continuous bead of silicone 1/2" from each side of the rough opening as shown above.

8

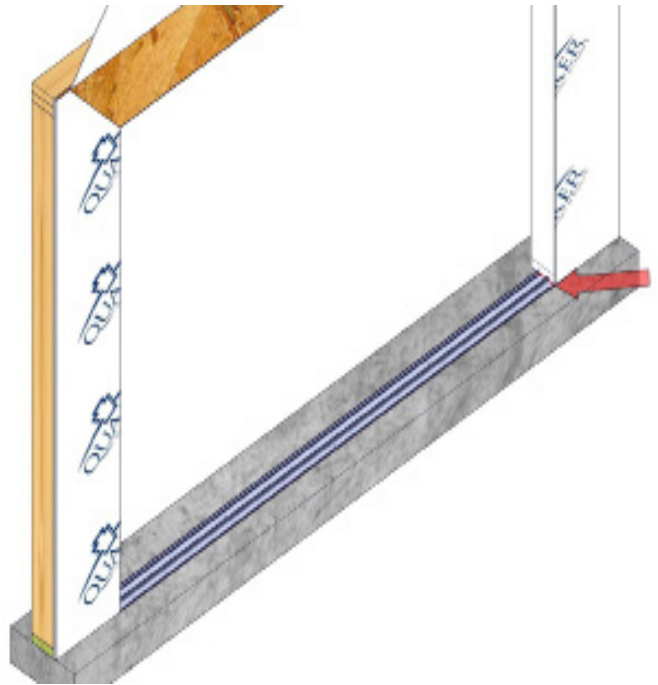

Install the sub-sill anchor plate keeping the exterior edge of sub-sill anchor plate in line with exterior of wall framing.

9

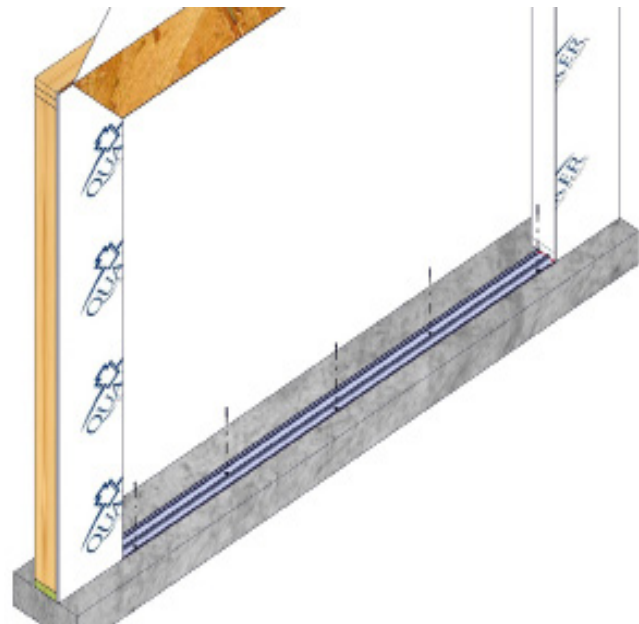

Fasten sub-sill anchor plate as shown above.

10

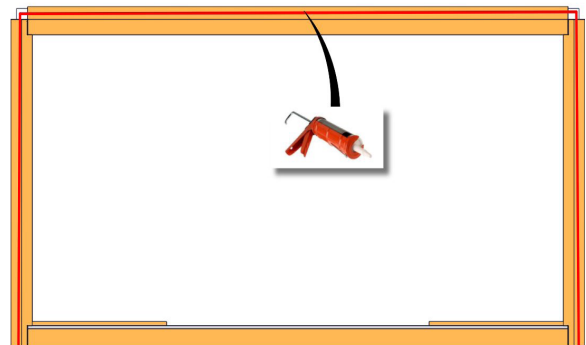

Apply a continuous 3/8" bead of sealant along the backside of the nailing flange. Bead must run around both sides and across the head, in line with and completely covering the nail holes.

11

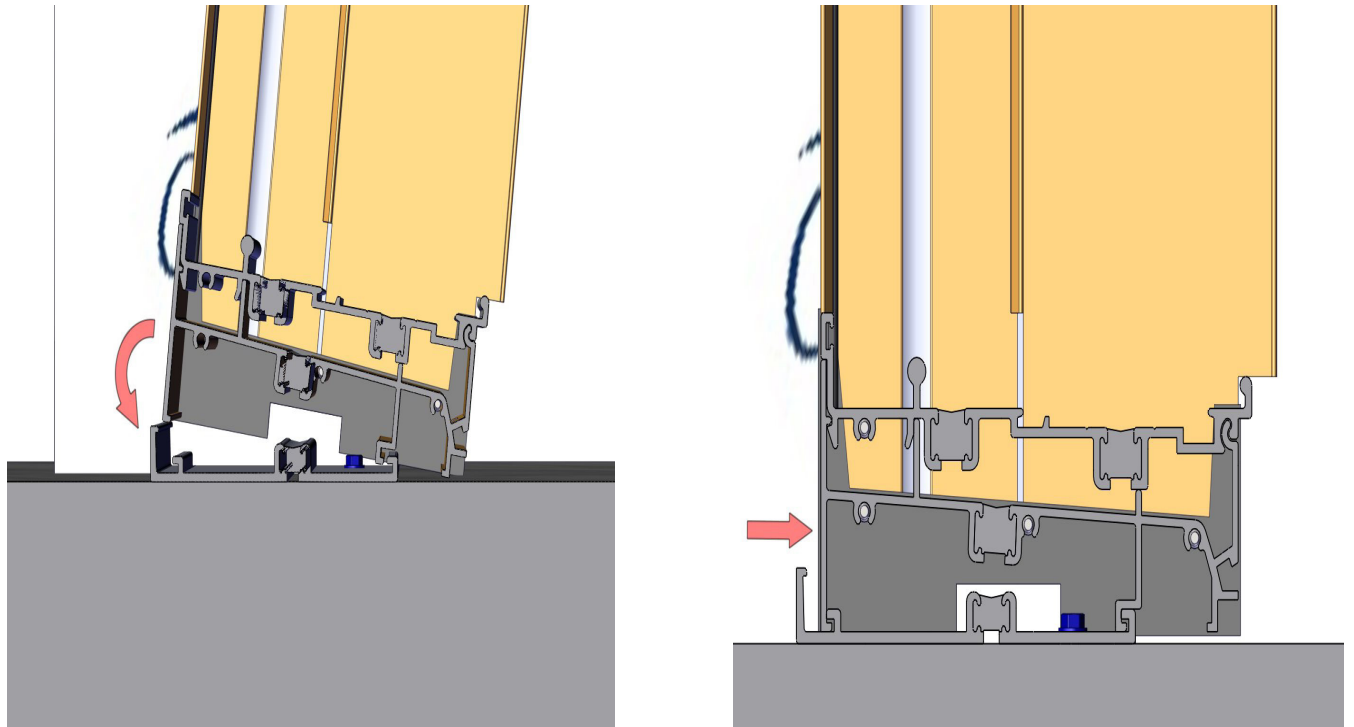

Center and set the door frame into the rough opening, making sure there are equal gaps on both sides of the door. Angle the door frame with the top tilted out, and set the exterior sill frame inside the exterior leg of the sub-sill anchor plate. Push the frame in against the framing locking the sill into the sub-sill anchor plate.

12

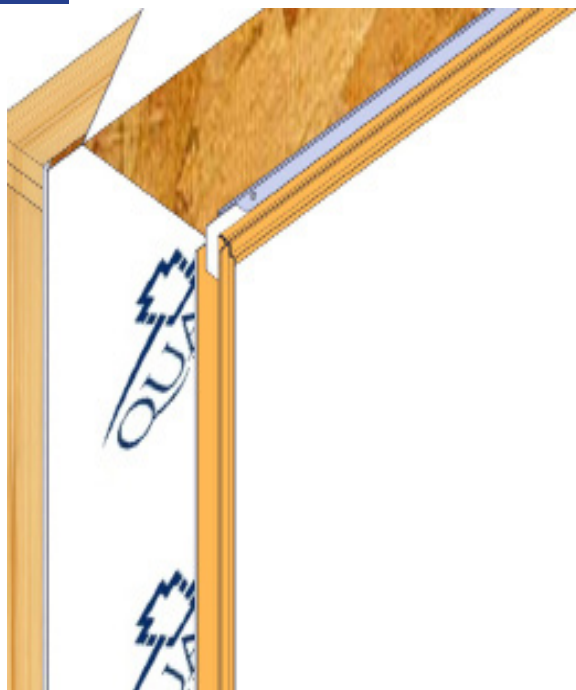

Temporarily tack the door into place using 2" galvanized roofing nails through the pre-punched hole on one top corner of nailing flange.

13

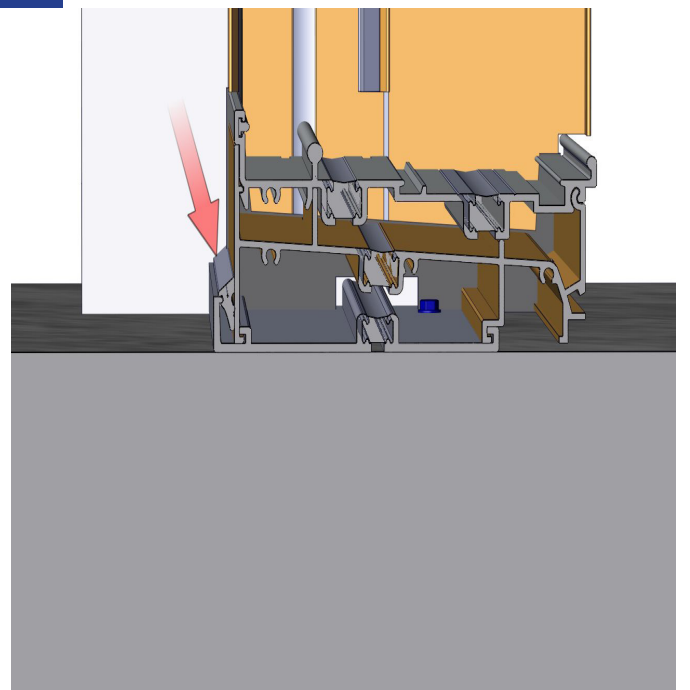

Install the wedge gasket in the sub-sill anchor plate against the interior leg of the door as shown above.

14

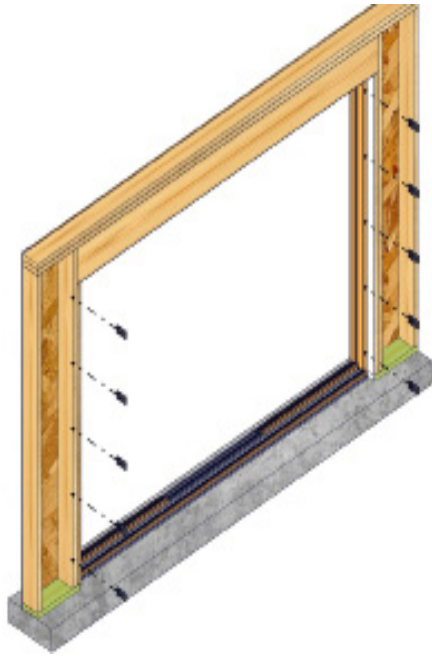

Shim at the sides of the door, and at the lock location as shown above. Never shim at the head.

15

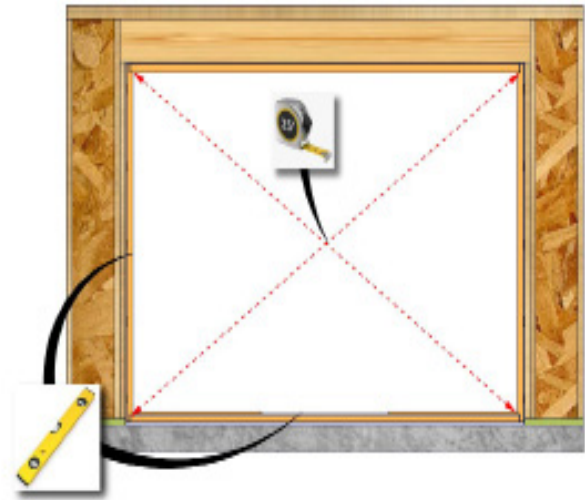

Check that the door is square. Adjust shims as needed until diagonal measurements are within 1/8". Level at the sill and plumb the frame.

16

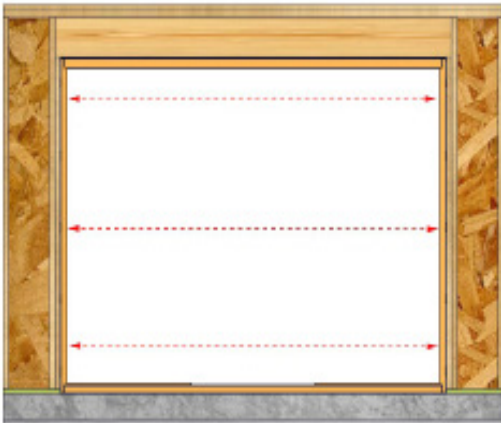

Check that the door frame is not bowed. Adjust shims as needed until measurements are within 1/8". Finish fastening the unit every hole or a minimum of 12" on center.

17



Apply flashing tape at the sides of the door as shown. Smooth using J-roller. Extend tape a minimum of 2" past window frame.

18



Apply a 3/8" sealant bead to the top exterior edge of door frame before installing the drip cap.
Apply flashing over the drip cap leg, overlapping the side flashing as shown. Smooth using a J-roller.

 Side flashing cannot extend above the top flashing. Doing so could result in product or property damage.

19

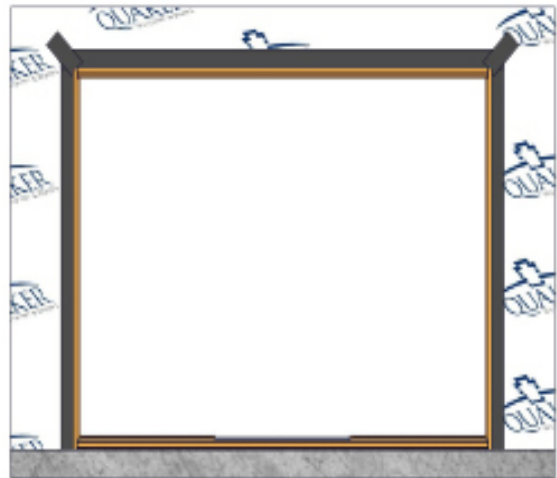

Unfold the house wrap top flap and tape the angled seams as shown.

20

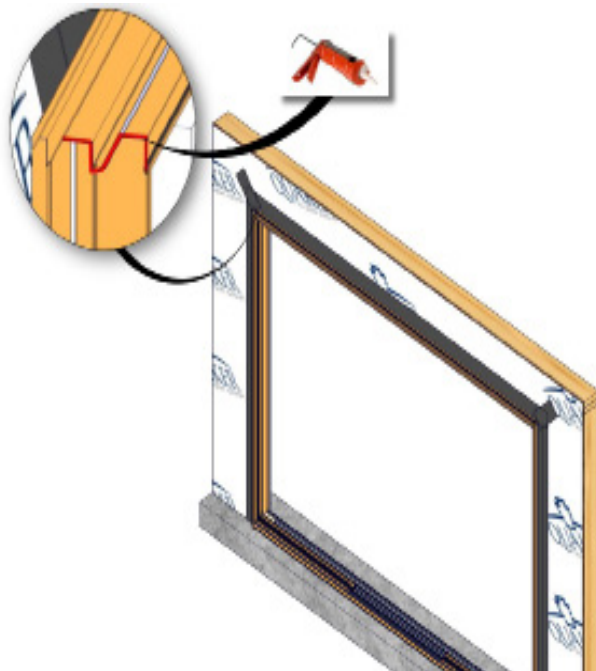

Seal the inside edge corners at the head and sill where the fixed panel will set in the frame.

21

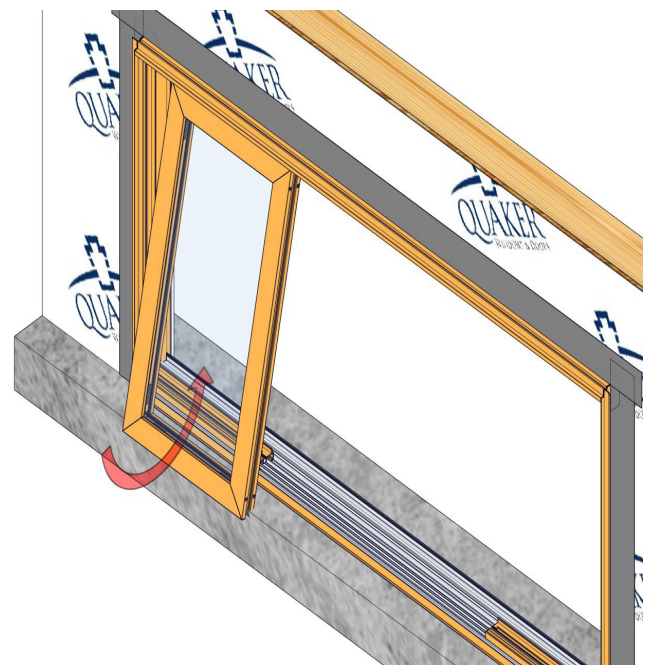

Angle the fixed panel with the top inserted into the head track, and then lift and set the bottom of the panel on the fixed panel extrusion in the sill.

22

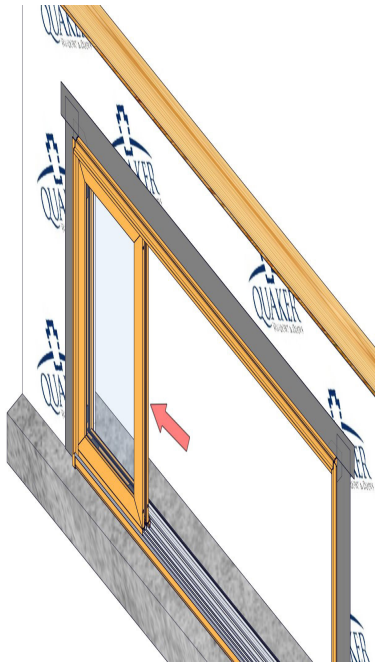

Slide the panel tight against the frame keeping the panel flush with the fixed panel extrusion in the sill.

23

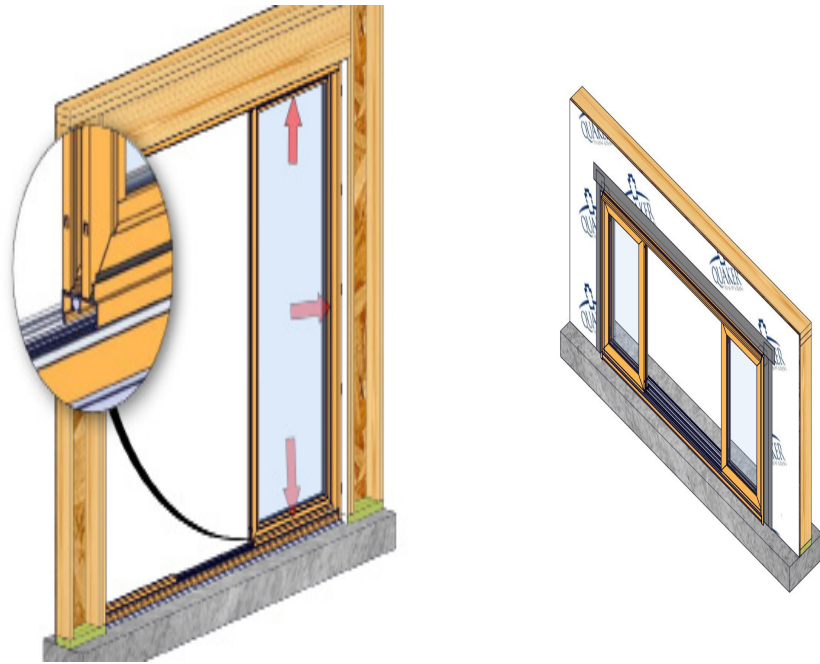

Install wedge gasket in the sill, head, and jamb around the interior of the frame and panel to secure the panel in place. Repeat steps 21, 22, and the first step of 23 for the other stationary panel.

24a

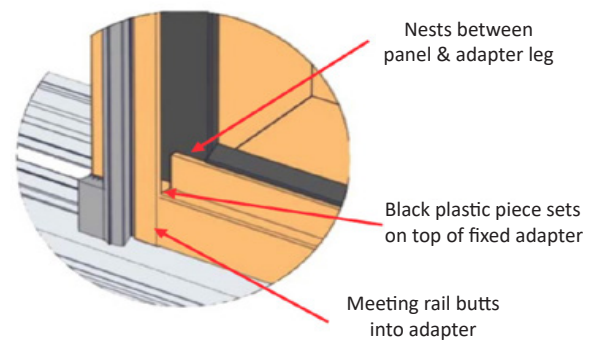
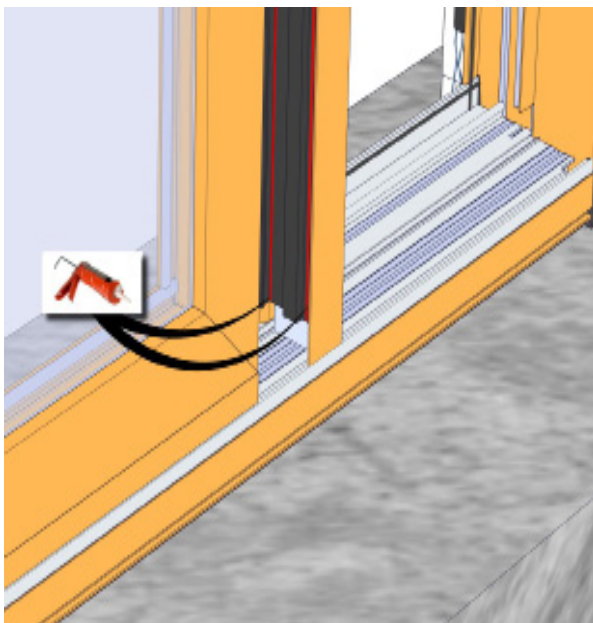

Apply a bead of sealant to inside edges of meeting rail before sliding the pre-assembled meeting rail against the fixed panel. Please see steps 24b and 24c for series specific guidelines.

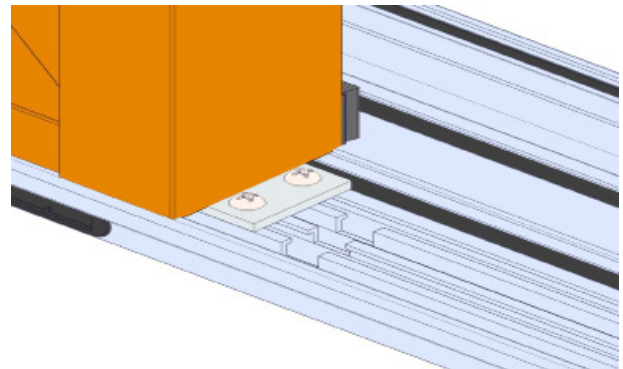
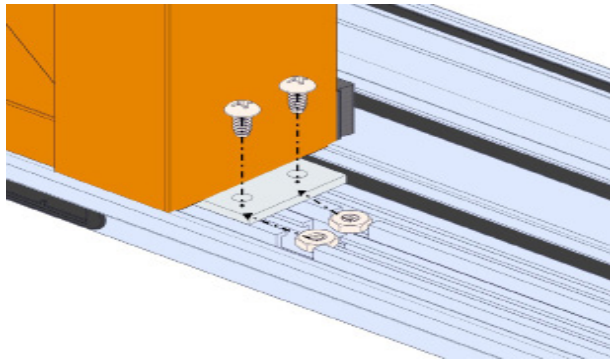
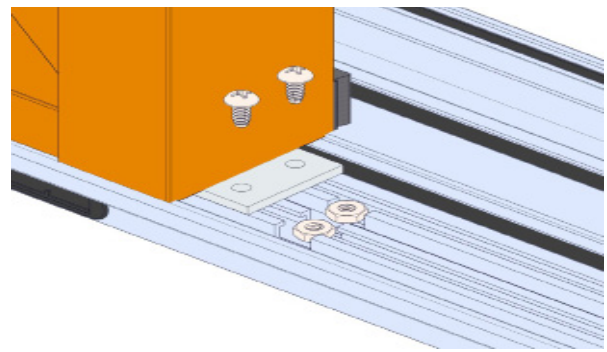
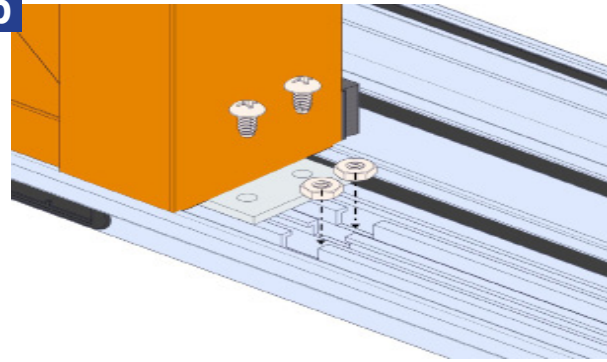
24b

For ModernVu and M204 units, install the meeting rail using supplied (MH8-18X1/2 TK2) screws in the head, and (MP10/24X3/8 & 10-24 NUT) screws and nuts in the sill angle brackets.

For all other M-Series units, please see step 24c.

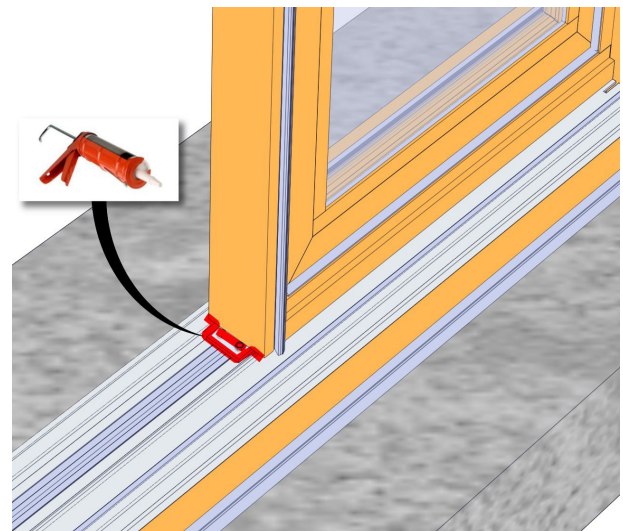
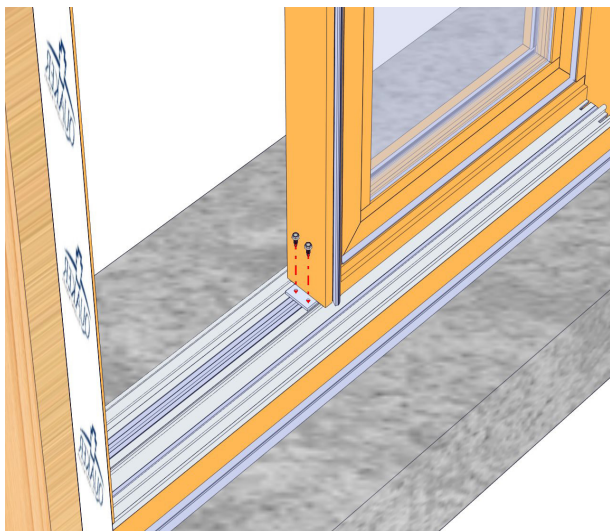
24c

For all other M-Series units, install the pre-assembled meeting rail against the fixed panel and install using supplied (MH8-18X1/2 TK2) screws in the head and sill angle brackets.

Apply sealant over the screw heads in the sill and along the perimeter of the angle bracket.

25

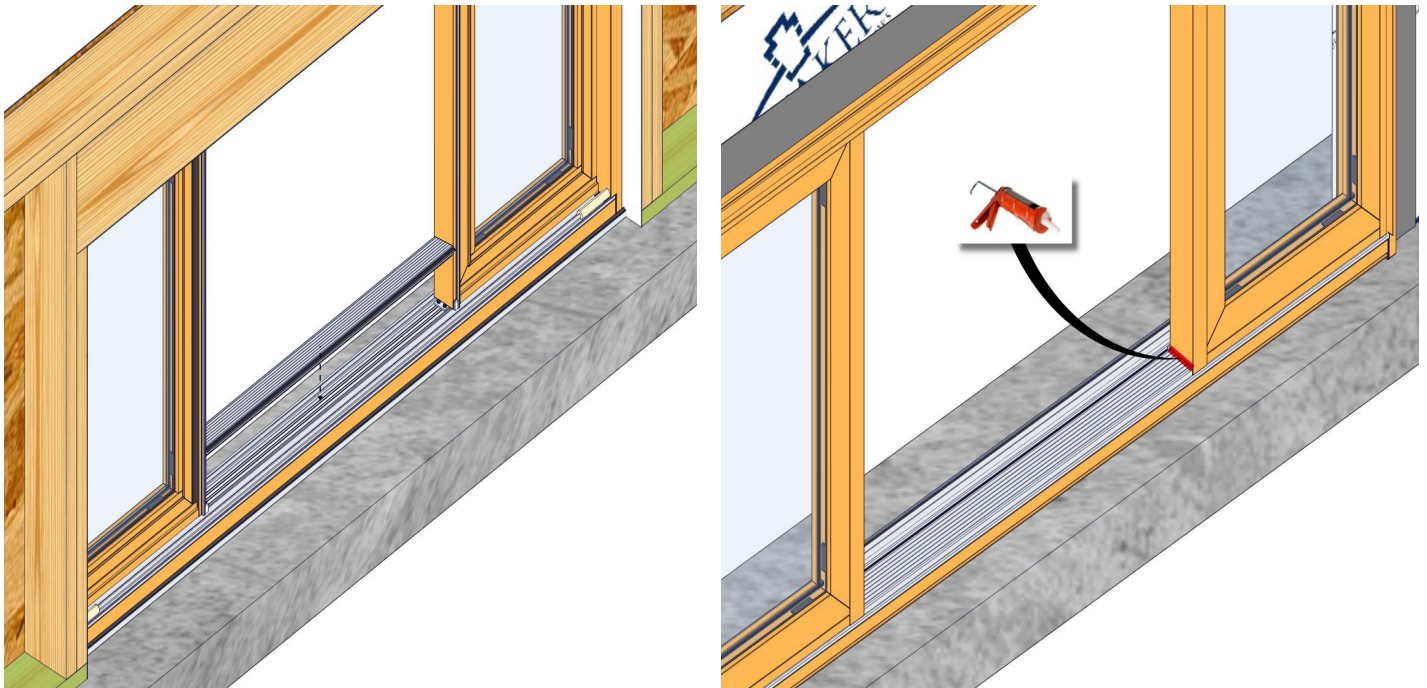

Install threshold on the exterior side of frame covering the bottom L-angle bracket. Seal around the two ends of the threshold against the frame.

26

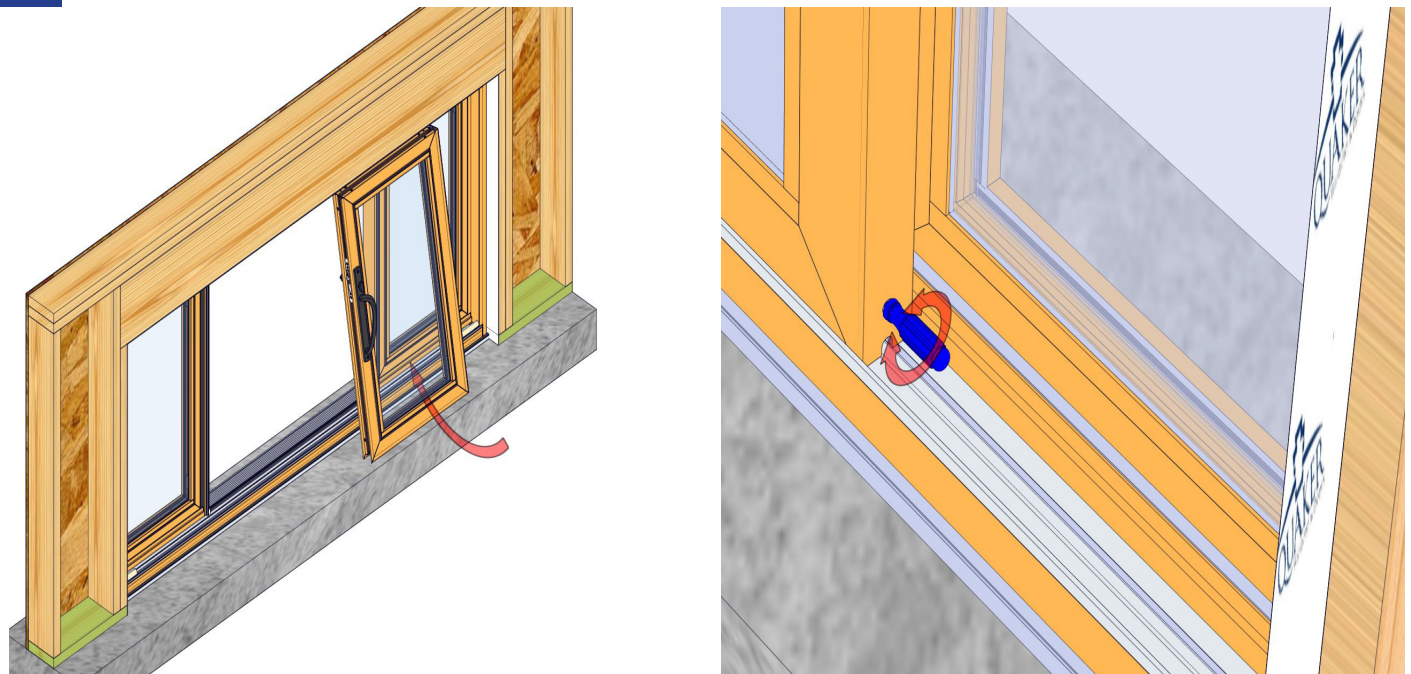

Angle the active panel with the top inserted into the head track, and then lift and set the bottom rollers on the roller track. Use a Phillips #3 screwdriver to adjust the rollers as needed to ensure the panel is level, square, and slides smoothly. Lift on the panel while adjusting, do not use a drill to adjust. Repeat above steps for the other active panel.

27

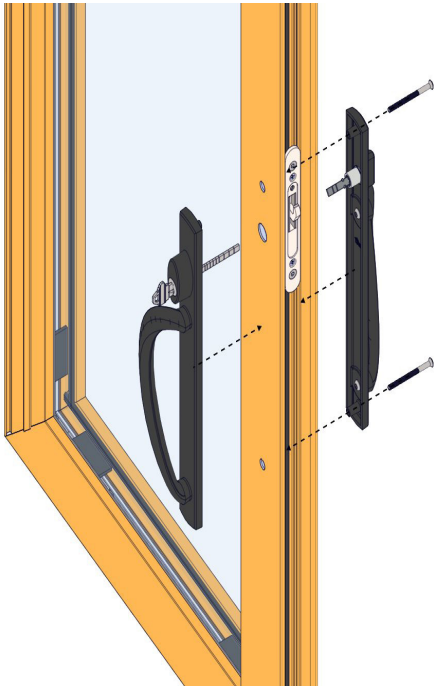

Install handle set using provided instructions found in the hardware box.

28



Install astragal to one active panel with provided screws. Make sure the lock notch matches up with lock.

29

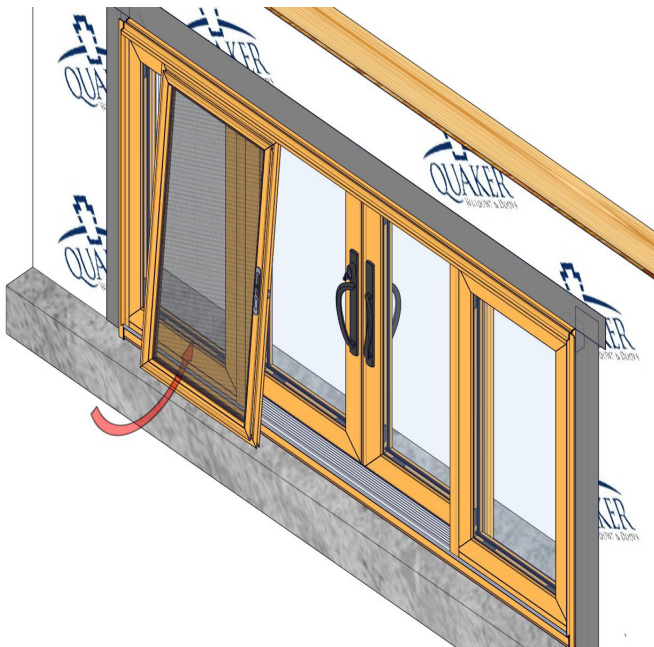

Angle the screen panel with the top inserted into the head track, and then lift and set the bottom rollers on the roller track. Adjust rollers as needed to insure the panel is level, square, and slides smoothly. Repeat above steps for the other screen.

30



Snap the screen astragal piece into one of the screen ends.

31

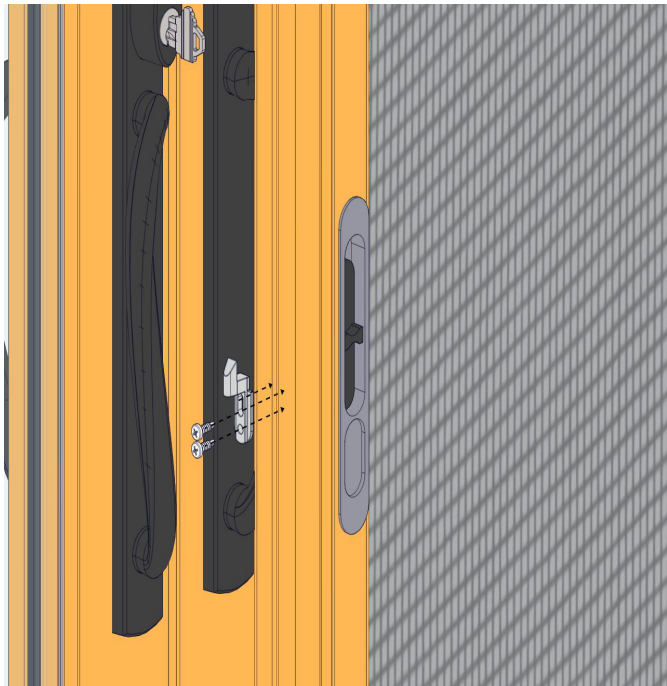

Install screen lock keeper into astragal rail.

32

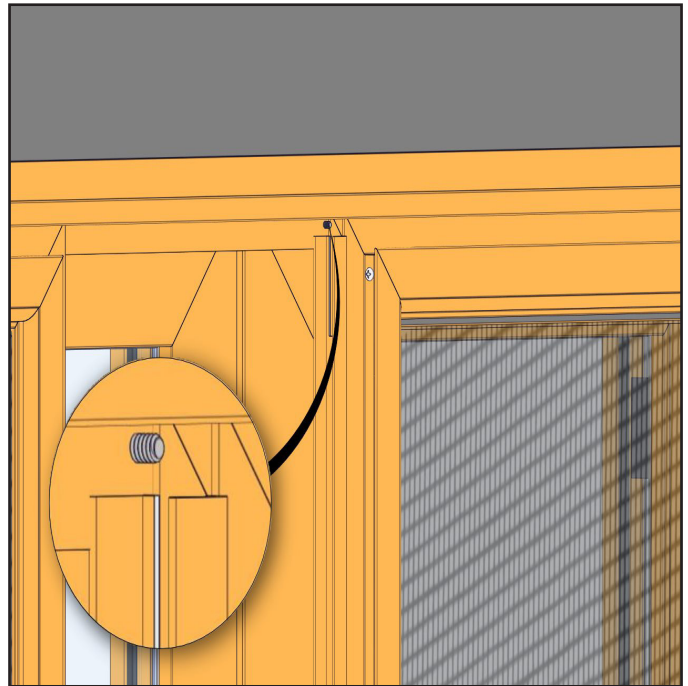

Install a stop screw into the head frame to keep screens centered when locked.

33

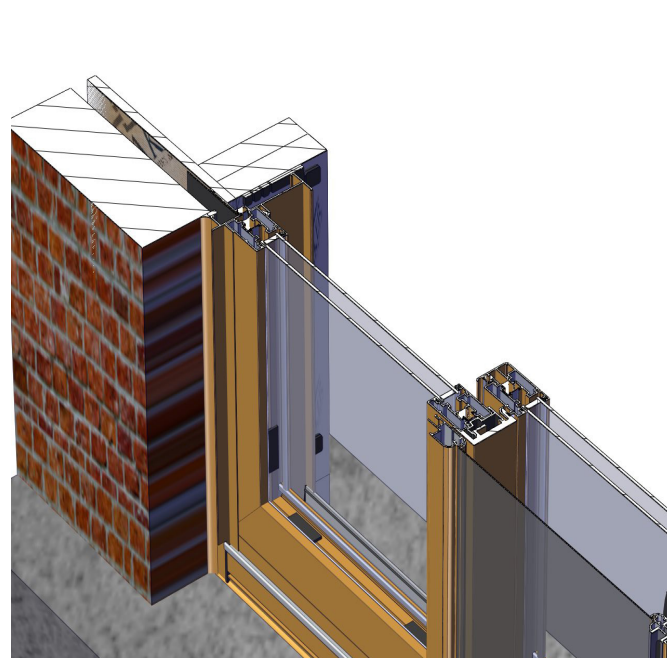

Apply sealant continuously around entire perimeter of opening, filling interior 1/3 of cavity using low expanding foam or backer rod and sealant.

34a

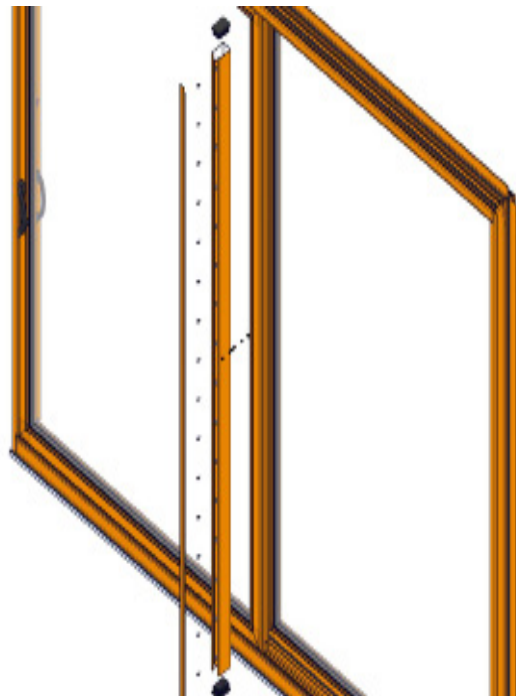

If reinforcement tube is to be applied, center the reinforcing tube on the active panel's meeting rail, and install using supplied (MH8-18x1/2 TK2) screws.

34b

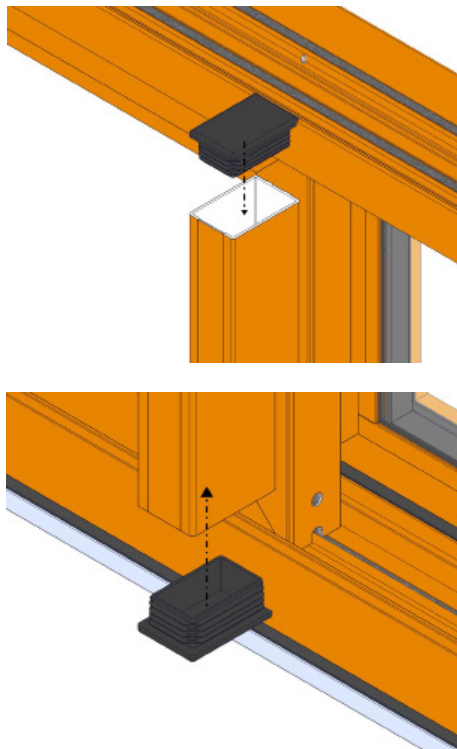
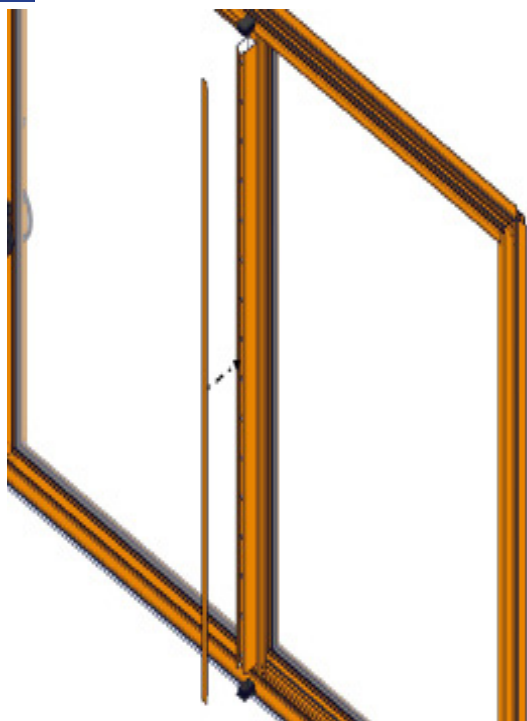

Install reinforcing cover and end caps to reinforcing tube.
Repeat for second active panel.



Installation Guidelines

For M-Series aluminum sliding 4 panel patio doors. New construction nail fin installation with a drainable weather resistant barrier.

If this set of instructions doesn't match your installation method or wall conditions please check our website listed below for other options, or call the office.

Scan here for a digital version of these guidelines in English



Scan here for a digital version of these guidelines in Spanish



Or go to: <http://quakerwindows.com/installation-instructions-videos/>

Or go to: <http://quakerwindows.com/installation-instructions-spanish/>

